

# SANTO K 78800 i

Built-In Refrigerator

Operating and Installation Instructions

## Dear customer,

Before placing your new refrigerator/freezer into operation please read these operating instructions carefully. They contain important information for safe use, for installation and for care of the appliance.

Please keep these operating instructions for future reference. Pass them on to possible new owners of the appliance.

These operating instructions are for use with several technically comparable models with varying accessories. Please observe the notes which apply to your model.



Notes which are important for your safety or for the proper functioning of the appliance are stressed with a warning triangle and/ or with signal words (**Warning!**, **Caution!**, **Important!**). Please observe the following carefully.



1. This symbol guides you step by step in the operation of the appliance.
- 2.



Supplementary information regarding operation and practical applications of the appliance appear after this symbol.



Tips and notes concerning economical and environmentally sound use of the appliance are marked with the cloverleaf.

The operating instructions contain instructions for the correction of possible malfunctions by the user in the section "What to do if ...". If these instructions should not be sufficient, please contact your local Service Force Centre.

Printed on paper manufactured with environmentally sound processes  
he who thinks ecologically acts accordingly...

# Contents

<b>Important Safety Instructions</b> .....	4
<b>Disposal</b> .....	6
Appliance Packaging Information.....	6
Disposal of old Appliances .....	6
<b>Remove transport packaging</b> .....	6
<b>Installation</b> .....	7
Installation Location.....	7
Your refrigerator needs ventilation .....	7
<b>Instructions for building-in the appliance</b> .....	8
Reversing the door.....	8
Building-in.....	8
Electrical Connection.....	11
<b>Description of the appliance</b> .....	12
View of the appliance.....	12
<b>Prior to Initial Start-Up</b> .....	13
<b>Starting up and temperature regulation</b> .....	13
<b>Switching off the appliance</b> .....	14
<b>Interior Accessories</b> .....	14
Storage shelves .....	14
Variable inner door.....	15
<b>Correct storage</b> .....	15
<b>Defrosting</b> .....	15
The fridge defrosts automatically .....	15
<b>Cleaning and Care</b> .....	16
<b>Energy Saving Tips</b> .....	17
<b>What to do if....</b> .....	17
Correcting Malfunctions .....	17
<b>Changing the light bulb</b> .....	19
<b>Noises during Operation</b> .....	19
<b>Regulations, Standards, Guidelines</b> .....	20
<b>Technical terminology</b> .....	21



## Important Safety Instructions

These warnings are provided in the interests of your safety. Ensure you fully understand them before installing or using the appliance. Your safety is of paramount importance. If you are unsure about the meaning of these warnings contact the Customer Care Department for assistance.

### Intended use

- The refrigerator is intended for use in the home. It is suitable for the storing of food at low temperature. If the appliance is used for purposes other than those intended or used incorrectly, no liability can be accepted by the manufacturer for any damage that may be caused.
- Alterations or changes to the refrigerator are not permitted for reasons of safety.
- If you use the refrigerator in a commercial application or for purposes other than the cooling of foods, the manufacturer accepts no liability for any damages which may occur.

### Prior to initial start-up

- Check the appliance for transport damage. Under no circumstance should a damaged appliance be plugged in. In the event of damage, please contact your supplier.
- Ensure that the appliance does not stand on the electrical supply cable. **Important:** if the supply cable is damaged, it must be replaced by authorised service or qualified personnel using a special cable of the same type.

### Refrigerant

The refrigerant isobutane (R600a) is contained within the refrigerant circuit of the appliance, a natural gas with a high level of environmental compatibility, which is nevertheless flammable.

- During transportation and installation of the appliance, be certain that none of the components of the refrigerant circuit become damaged.
- If the refrigerant circuit should become damaged:
  - avoid open flames and sources of ignition;
  - thoroughly ventilate the room in which the appliance is situated.

### Safety of children

- Packaging (e.g. wraps, polystyrene) can be dangerous for children. There is a risk of suffocation! Keep packaging material away from children!

- Please make old appliances unusable prior to disposal. Pull out the mains plug, cut off the mains cable, break or remove spring or bolt catches, if fitted. By doing this you ensure that children cannot lock themselves in the appliance when playing (there is risk of suffocation!) or get themselves into other dangerous situations.
- Often children cannot recognise the hazards present in household appliances. It is therefore important that you ensure adequate supervision and never let children play with the appliance!

### Daily Operation

- Containers with flammable gases or liquids can leak at low temperatures. There is a risk of an explosion! Do not store any containers with flammable materials such as spray cans, fire extinguisher refill cartridges etc in the refrigerator/freezer.
- Do not operate any electrical appliances in the refrigerator/freezer (e.g. electric ice cream makers, mixers etc.).
- Before cleaning the appliance, always switch off the appliance and unplug it, or disconnect from the electricity supply.
- When unplugging always pull the plug from the mains socket, do not pull on the cable.

### In case of malfunction

- If a malfunction occurs on the appliance, please look first in the "What to do if ..." section of these instructions. If the information given there does not help, please do not perform any further repairs yourself.
- This product should be serviced by an authorised engineer and only genuine spare parts should be used.
- Under no circumstances should you attempt to repair the appliance yourself. Repairs carried out by inexperienced persons may cause injury or serious malfunctioning. Contact your local AEG Service Force Centre.

# Disposal

## Appliance Packaging Information

All materials are environmentally sound! They can be disposed of or burned at an incinerating plant without danger.

About the materials: The plastics can be recycled and are identified as follows:

>PE< for polyethylene, e.g. the outer covering and the bags in the interior.

>PS< for polystyrene foam, e.g. the pads, which are all free of chlorofluorocarbon.

The carton parts are made from recycled paper and should be disposed of at a waste-paper recycling collection location.

## Disposal of old Appliances

For environmental reasons, refrigeration appliances must be disposed of properly. This applies to your old appliance, and - at the end of its service life - for your new appliance as well.



**Warning!** Before disposing of old appliances make them inoperable. Remove plug from mains, sever the power cable, remove or destroy any snap or latch closures. This ensures that playing children do not lock themselves inside the appliance (danger of suffocation!) or place themselves into other life-endangering situations.

### Disposal:

- The appliance may not be disposed of with domestic waste or bulky refuse.
- The refrigerant circuit, especially the heat exchanger at the back of the appliance, must not be damaged.
- Information concerning collection schedules or locations can be obtained from your local Council or Environmental Health Office.

## Remove transport packaging

The appliance and the interior fittings are protected for transport.



1. Pull off the adhesive tape on the left and right side of the door.



You can remove any remnants of adhesive using white spirit.

2. Remove all adhesive tape and packing pieces from the interior of the appliance.

# Installation

## Installation Location

The appliance should be set up in a well ventilated, dry room.

Energy use and efficient performance of the appliance is affected by the ambient temperature.

The appliance should therefore

- not be exposed to direct sunlight;
- not be installed next to radiators, boilers or in a very cold room e.g. an outhouse;
- only be installed at a location whose ambient temperature corresponds to the climate classification, for which the appliance is designed.

The climate classification can be found on the rating plate, which is located at the left on the inside of the appliance.

The following table shows which ambient temperature is correct for each climate classification:

Climate classification	for an ambient temperature of
SN	+10 to +32 °C
N	+16 to +32 °C
ST	+18 to +38 °C
T	+18 to +43 °C

If the refrigeration appliance is installed next to another refrigerator or freezer a clearance of 5 cm at the sides is required, in order to prevent the formation of condensation on the outside of the appliance.

## Your refrigerator needs ventilation

### Integratable models (i-appliances)

The integrated door of the furniture cabinet largely seals the installation recess. i-appliances must therefore be provided with ventilation by having an opening in the furniture plinth. The warmed air must be able to be exhausted upwards through the air shaft on the furniture back.

The ventilation cross-sections should be at least 200 cm<sup>2</sup>.

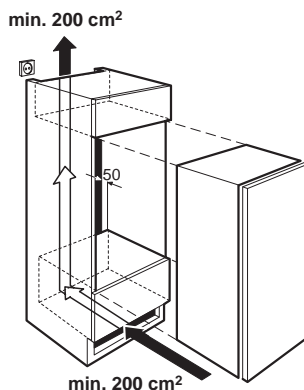

**Important note!** In order not to impair the function of the appliance, never cover or obstruct the ventilation openings.

## Instructions for building-in the appliance

### Reversing the door

 The appliance's door has been locked in position for transport by means of pins on both sides. According to the door opening direction, remove relevant pins at the top and at the bottom.

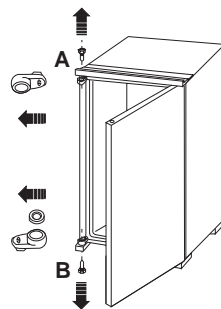

### Building-in

#### Dimensions of the recess

Height of housing 880 mm

Depth of housing 550 mm

Width of housing 560 mm

It is necessary that the cabinet has a ventilation recess with the following dimensions:

Depth 50 mm

Width 540 mm

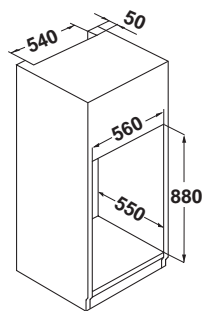

 1. Press in the joint covers between the appliance and the kitchen furniture.

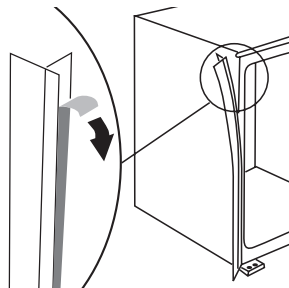



2. Push the appliance into the housing until stop strip (A) touches the kitchen unit.

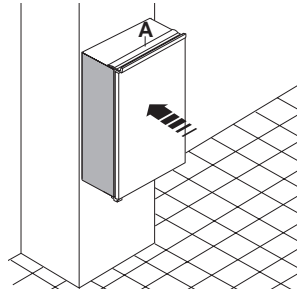

3. Open the door and push the appliance against the side of kitchen furniture opposite to that of appliance hinges.
4. Fasten the appliance with 4 screws provided in the kit included with the appliance.
5. Snap vent grille (C) and hinge cover (D) into position.

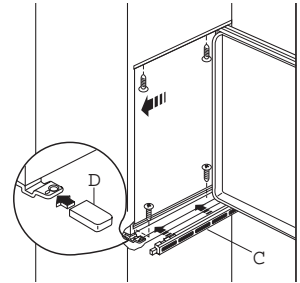

6. Apply blanking covers (B) as indicated.

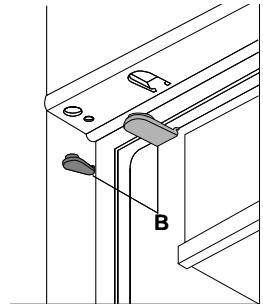

7. Separate parts A, B, C, D as shown in the figure.

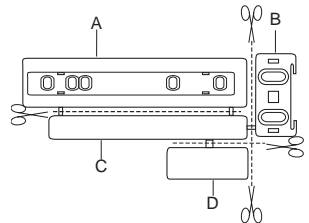

## Instructions for building-in the appliance

8. Place guide (A) on the inside part of the furniture door, upper and lower positions as shown in the figure and mark the position of external holes. After having drilled holes, fix the guide with the screws supplied.

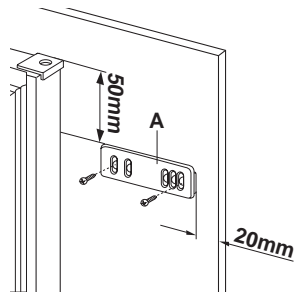

9. Fix cover (C) on guide (A) until it clips into place.

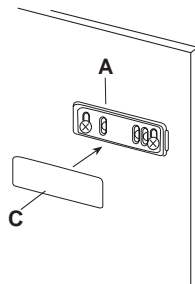

10. Open the appliance door and the furniture door at 90°. Insert the small square (B) into guide (A).

11. Put together the appliance door and the furniture door and mark the holes as indicated in the figure.

12. Remove the squares and drill holes with  $\varnothing$  2 mm at 8 mm from the outer edge of the door. Place the small square on the guide again and fix it with the screws supplied.

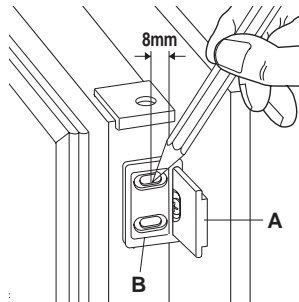

13. Should the lining up of the furniture door be necessary, use the clearance of slots. At the end of operations, it is necessary to check if the door of the furniture closes properly.

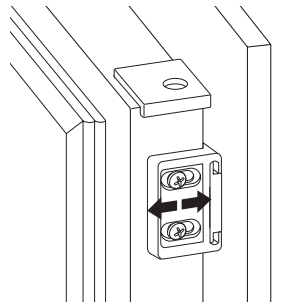

14. Fix cover (D) on guide (B) until it clips into place.

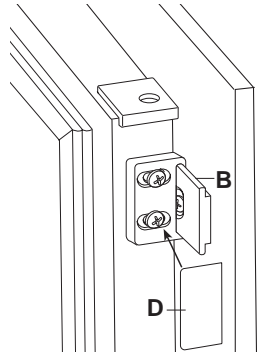

## Electrical Connection

Any electrical work required to install this appliance should be carried out by a qualified electrician or competent person.



### WARNING – THIS APPLIANCE MUST BE EARTHED

The manufacturer declines any liability should these safety measures not be observed.

Before switching on, make sure the electricity supply voltage is the same as that indicated on the appliance rating plate. The rating plate is inside, on the left.

The appliance is supplied with a 13 amp plug fitted. In the event of having to change the fuse in the plug supplied, a 13 amp ASTA approved (BS 1362) fuse must be used.

### Important

The wires in the mains lead are coloured in accordance with the following code:

Green and Yellow:	Earth
Blue:	Neutral
Brown:	Live

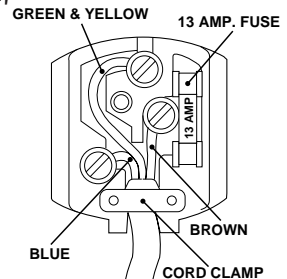

As the colours of the wires in the mains lead of this appliance may not correspond with the coloured markings identifying the terminals in your plug, proceed as follows:

1. The wire coloured green and yellow must be connected to the terminal marked with the letter "E" or by the earth symbol or coloured green and yellow.
2. The wire coloured blue must be connected to the terminal "N" or coloured black.

## Description of the appliance

3.The wire coloured brown must be connected to the terminal marked "L" or coloured red.

4.Upon completion there must be no cut, or stray strands of wire present and the cord clamp must be secure over the outer sheath.



**Warning!** A cut-off plug inserted into a 13 amp socket is a serious safety (shock) hazard. Ensure that the cut-off plug is disposed of safely.

## Description of the appliance

### View of the appliance

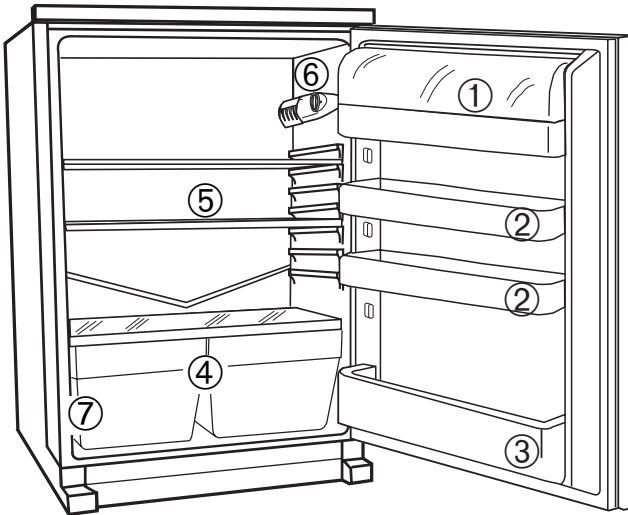

- ① Butter/cheese compartment
- ② Door shelves
- ③ Bottle shelf
- ④ Vegetable drawers
- ⑤ Storage shelves
- ⑥ Thermostat
- ⑦ Rating plate

## Prior to Initial Start-Up

-  Please clean the appliance interior and all accessories prior to initial start-up (see section: "Cleaning and Care").

## Starting up and temperature regulation

**Important!** Only use the appliance when built-in!

-  1. Connect the appliance to the mains electricity supply.  
When the refrigerator compartment door is opened, the internal lighting is switched on.

The temperature control knob is located on the right hand side of the refrigerator compartment.

**Setting "0" means: Off.**

2. Turn the control knob clockwise past "1". The refrigerating unit is now on and operates automatically.

**Setting "1" means:**

Highest temperature, warmest setting.

**Setting "6" (end-stop) means:**

Lowest temperature, coldest setting.



**Note:** From a food safety point of view +5 °C should be considered sufficiently cold for storing food in the fridge.

At a low ambient temperature of around 16°C, setting "1" should be selected. At ambient temperatures of around 25°C, select setting "2". If you require a lower temperature, select setting "3" or "4".

**Important!**

High ambient temperatures (e.g. on hot summer days) and a cold setting on the thermostat (position "5" to "6") can cause the compressor to run continuously.

Reason: when the ambient temperature is high, the compressor must run continuously to maintain the low temperature in the appliance. The fridge will not be able to defrost since automatic defrosting of the fridge is only possible when the compressor is not running (see also "Defrosting" section). The result is the build up of a thick layer of frost on the fridge rear wall.

If this happens, turn the thermostat knob back to a warmer setting (position "3" to "4"). At this setting the compressor will be switched on and off as usual and automatic defrosting recommenced.

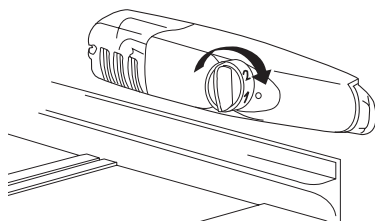

# Switching off the appliance

☞ To switch off the appliance, turn the temperature regulator to position "0".

If the appliance is not going to be used for an extended period:

- ☞ 1. Remove all refrigerated packages.
2. Switch off the appliance by turning the thermostat knob to position "0".
3. Remove the mains plug or switch off or disconnect from the electricity supply.
4. Clean thoroughly (see section: "Cleaning and Care").
5. Leave the door open to avoid the build up of odours.

## Interior Accessories

### Storage shelves

Various glass storage shelves are included with your appliance.

The height of the storage shelves can be adjusted:

- ☞ 1. To do this pull the storage shelf forward until it can be swivelled upwards or downwards and removed.
2. Please do the same in reverse to insert the shelf at a different height.

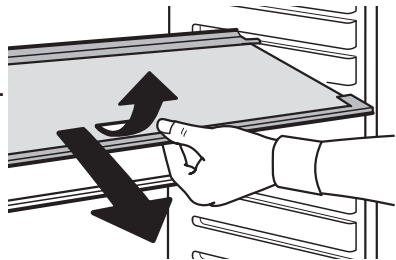

Your appliance is equipped with two half size glass storage shelves.

Storing tall items:

- ☞ Slide the front half of the Vario storage shelf in another level to the rear. By this means you will gain space to place tall items on the storage shelf below.

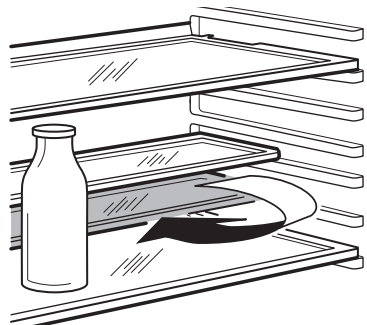

## Variable Inner Door

The door compartments can be pulled up and removed, and inserted at other positions as needed.

## Correct storage

For physical reasons, there are different temperature regions in the fridge. The coldest region is on the lowest storage shelf. Warmer regions are the top storage shelf, the vegetable drawer and the storage compartments on the door. The arrangement example shows at which places in the refrigerator suitable temperatures for various types of foods exist. The length of storage time depends on the type of food - see manufacturer's instructions.

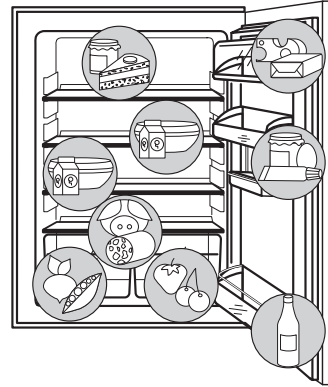

**Tip:** Food in the fridge should always be covered or packaged, to prevent drying and tainting of other food.

The following are suited for packaging:

- Polyethylene airtight bags and wraps;
- Plastic containers with lids;
- Special plastic covers with elastic;
- aluminium foil.

## Defrosting

### The fridge defrosts automatically

The rear wall of the fridge covers with frost when the compressor is running, and defrosts when the compressor is off. The water from the thawing frost evaporates by itself.

The water drainage hole must be cleaned regularly (see the section "Cleaning and Care").

# Cleaning and Care

For hygienic reasons the appliance interior, including interior accessories, should be cleaned regularly.



## Warning!

- The appliance must not be connected to the mains during cleaning. Danger of electrical shock. Before cleaning switch the appliance off and remove the plug from the mains, or disconnect from the electricity supply.
- Never clean the appliance with a steam cleaner. Moisture could accumulate in electrical components and there is a danger of an electrical shock. Hot vapours can lead to the damage of plastic parts.
- The appliance must be dry before it is placed back into service.

## Important!

- Ethereal oils and organic solvents can attack plastic parts, e.g.
  - lemon juice or the juice from orange peals;
  - butyric acid;
  - cleansers which contain acetic acid.Do not allow such substances to come into contact with appliance parts.
- Do not use any abrasive cleansers.



1. Remove the food from the refrigerator. Store it in a cool place, well covered.
2. Switch the appliance off and remove the plug from the mains, or disconnect from the electricity supply
3. Clean the appliance and the interior accessories with a cloth and luke-warm water.
4. After cleaning wipe with fresh water and rub dry.
5. Check the water drain hole in the rear wall of the refrigeration chamber is not blocked. Clear a blocked drain hole with the aid of the green peg in the pack of accessories included with the appliance.
6. After everything is dry place appliance back into service.

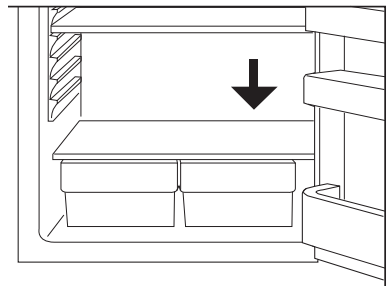

To guarantee a safe operation of the fridge, once a year remove the ventilation grille at the base and clean the air channels with a vacuum cleaner.





## Energy Saving Tips

- Do not install the appliance near boilers, radiators or other sources of heat. High ambient temperatures cause longer, more frequent operation of the compressor.
- Ensure sufficient air circulation and exhaust at the appliance base and at the back wall of the appliance. Never cover air vent openings.
- Do not place warm foods into the appliance. Allow warm foods to cool first.
- Do not leave the door open any longer than necessary.
- Do not set temperature any colder than necessary.
- Put frozen food in the fridge to defrost. The cold in the frozen food will then be used to cool the fridge.

## What to do if ...

### Correcting Malfunctions

A malfunction may be caused by only a minor fault that you can rectify yourself using the following instructions. Do not perform any other work on the appliance if the following information does not provide assistance in your specific case.



**Important!** Repairs to refrigerators/freezers may only be performed by competent service engineers. Improper repairs can give rise to significant hazards for the user. If your appliance needs repairing, please contact your specialist dealer or your local Service Force Centre.

Symptom	Possible Cause	Remedy
Appliance does not work.	Appliance is not switched on.	Switch on the appliance.
	Mains plug is not plugged in or is loose.	Insert mains plug.
	Fuse has blown or is defective	Check fuse, replace if necessary.
	Socket is defective.	Mains malfunctions are to be corrected by an electrician.
The compressor runs continuously.	Temperature is set too cold.	Turn the thermostat knob to a warmer setting temporarily.
Interior lighting does not work.	Light bulb is defective.	Please look in the "Changing the Light Bulb" section.
The food is too warm.	Temperature is not properly adjusted.	Please look in the "Initial Start Up" section.
	Door was open for an extended period.	Do not leave the door open any longer than necessary.
	A large quantity of warm food was placed in the appliance within the last 24 hours.	Turn the thermostat knob to a colder setting temporarily.
	The appliance is near a heat source.	Please look in the "Installation location" section.
Heavy build up of frost, possibly also on the door seal.	Door seal is not airtight (possibly after reversing the door).	Carefully warm the leaking sections of the door seal with a hair dryer (on a cool setting). At the same time shape the warmed door seal by hand such that it sits correctly.
The compressor does not start immediately after changing the temperature setting.	This is normal, no error has occurred.	The compressor starts after a period of time.
Water in the bottom of the cabinet.	Water drain hole is blocked.	See the "Cleaning and Care" section.

## Changing the light bulb



**Warning!** There is a risk of electric shocks! Before changing the light bulb, switch off the appliance and unplug it, or disconnect from the power supply.

Light bulb data: 220–240 V, max. 15 W

1. To switch off the appliance, turn the thermostat knob to position "0".
2. Unplug the mains plug.
3. To change the light bulb, undo the screw.
4. Press the light bulb cover as shown and slide it backwards.
5. Change the defective light bulb.
6. Refit the light bulb cover and the screw.
7. Put the refrigerator back into operation.

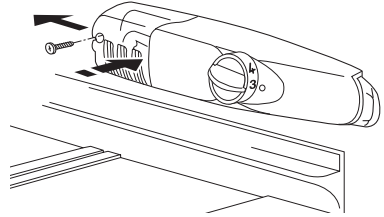

## Noises during Operation

The following noises are characteristic of refrigeration appliances:

- **Clicks**  
Whenever the compressor switches on or off, a click can be heard.
- **Humming**  
As soon as the compressor is in operation, you can hear it humming.
- **Bubbling/Splashing**  
When refrigerant flows into thin tubes, you can hear bubbling or splashing noises. Even after the compressor has been switched off, this noise can be heard for a short time.

## Regulations, Standards, Guidelines

This appliance was designed for household use and was manufactured in accordance with the appropriate standards. The necessary measures in accordance with appliance safety legislation regulations (GSG), accident prevention regulations for refrigeration appliances (VBG 20) and the regulations of the German Society of Electrical Engineers (VDE) were observed in the manufacture of this appliance. The refrigerant circuit has been checked for leaks.

**CE** This appliance is in accordance with the following EU guidelines:

- 73/23/EEG dated 19 February 1973 - low voltage guidelines.
- 89/336/EEG dated 3 May 1989  
(including guideline change notice 92/31/EEG) - EMV guideline

---

# Technical terminology

- **Refrigerant**

Liquids that can be used to generate a cooling effect are known as refrigerants. They have a relatively low boiling-point, indeed so low, that the warmth from the food stored in the fridge or freezer can cause the refrigerant to boil and vaporise.

- **Refrigerant Circuit**

Closed circulation system that contains the refrigerant. The refrigerant circuit comprises primarily of an evaporator, a compressor, a condenser and pipe work.

- **Evaporator**

The refrigerant is evaporated in the evaporator. Similar to all other liquids, refrigerant requires heat to evaporate. This heat is removed from the interior of the appliance, as a result the interior is cooled. The evaporator is therefore located inside the appliance or placed in foam immediately behind the inner wall and thus not visible.

- **Compressor**

The compressor looks like a small drum. It is driven by a built-in electric motor and is mounted on the base of the appliance at the rear. The task of the compressor is to draw in vaporised refrigerant from the evaporator, to compress it, and to pass it on to the condenser.

- **Condenser**

The condenser normally has the form of a grid. The refrigerant compressed in the compressor is liquefied in the condenser. During this process, heat is released to the surrounding air at the surface of the condenser. The condenser is mounted on the base of the appliance.





 **From the Electrolux Group. The world's No.1 choice.**

*The Electrolux Group is the world's largest producer of powered appliances for kitchen, cleaning and outdoor use. More than 55 million Electrolux Group products (such as refrigerators, cookers, washing machines, vacuum cleaners, chain saws and lawn mowers) are sold each year to a value of approx. USD 14 billion in more than 150 countries around the world.*

AEG Hausgeräte GmbH  
Postfach 1036  
D-90327 Nürnberg

<http://www.aeg.hausgeraete.de>

© Electrolux plc 2003

2222 754-51 -02- 0203

Subject to change without notice